

# Enterprise architecture frameworks with semantic models as a foundation for complex networked operations

## Process Modeling:

ARIS (ARchitecture of Integrated Scenarios) /

EPC (Event-Driven Process Chain)

OMG's BPMN (Business Process Modeling Notation)

# Agenda

- **(I) Enterprise Architecture, TOGAF, UPDM (Arne, Ulf, Dima)**
  - Zachman, TOGAF, MODAF/DODAF/NAF, MDA, UPDM - Arne
  - Saarstahl SHAPE - Dima
  - European ATM/SESAR - Ulf
- **(II) INFORMATION and ONTOLOGY MODELING (UML/ER, ODM/OWL with examples/tools) Arne (Ulf, Dima)**
  - Conceptual Modeling, Information Modeling, Ontologies - Ulf and Arne
  - ODM with OWL for semantic modeling (WSMT) - Dima
- **(III) PROCESS MODELING (EPC/BPMN with examples/tools) (Dima)**
  - ARIS/EPC (Event-Driven Process Chains) Dima
  - BPMN (Business Process Modeling Notation) Dima
- **(IV) SERVICE MODELING and Interoperability (SoaML with examples) (Arne)**
  - SoaML (Service oriented architecture Modeling Language) Arne
  - Semantic annotations, SAWSDL, from existing system specifications to an ontology can support semantic interoperability Arne

# Process Modeling: Definitions

“We define a process as a collection of activities that takes one or more kinds of input and creates an output that is of value for the customer” (Hammer, Champy 1993)

“The process means activities on the objects, its content is herewith activities and objects” (Nordsieck 1934)

“Under operational organization we understand the process of the task fulfillment under consideration of logical, personnel and space-time aspects” (Weidner 1990)

# Process Modeling

- Business processes are complex, and require people with various skills and abilities to work in a cooperative fashion
  
- Processes will not be efficient and effective unless:
  - They are clearly defined
  
  - Individuals are adequately trained in their roles
  
  - Individuals understand how their roles fit in the overall process
  
- Process Modeling tools provide a way to describe business processes

# Agenda

- Process Modeling
- Organizational and Operational Structure
- ARIS / EPC and BPMN:
  - Overview
  - Modeling Concepts

# Organizational and Operational Structure, Business Process

- **Organizational Structure:** static rules and hierarchies
- **Operational Structure:** time-logical activities for the task fulfillment of the enterprise
- **Business Process:** a sequence of enterprise activities, complete with regard to content, that produces values consumed by the customer

# Application Areas of Business Processes

- Business Process Analysis in BPR-Projects
- Documentation of the Workflow (e. g. Reference models)
- Specification or Choice and Configuration of Software
- Specification of Workflows
- Simulation
- Project Management
- Process Cost Calculation

# Business Process Classification

- After Correlation to Goals and Outputs
  - Main Processes
  - Service Processes
- After Execution Frequency
  - Routine Processes
  - Ruling Processes
  - One-Time Processes
- After (strategic) Value
  - Decision Processes
  - Execution Processes



# Agenda

- Process Modeling
- Organizational and Operational Structure
- ARIS / EPC and BPMN:
  - Overview
  - Modeling Concepts

# EPC: Overview

- Developed in 1992 in a project involving SAP at the DFKI Institute for Information Systems
- Based on Petri-Nets
- Doesn't require strong formal framework
- "Lean" modeling approach
- Purely chronological procedural sequence of process activities and events

(Dumas, van der Aalst 2005)

# EPC: Tools Examples

- Industrial :
  - IDS Scheer ARIS Toolset and Business Architect
  - SAP EPC representations for business processes its software supports
  
- Research:
  - CIMFlex – SHAPE project
  - KModeler – Paderborn University, Germany

# ARIS EPC Modeling

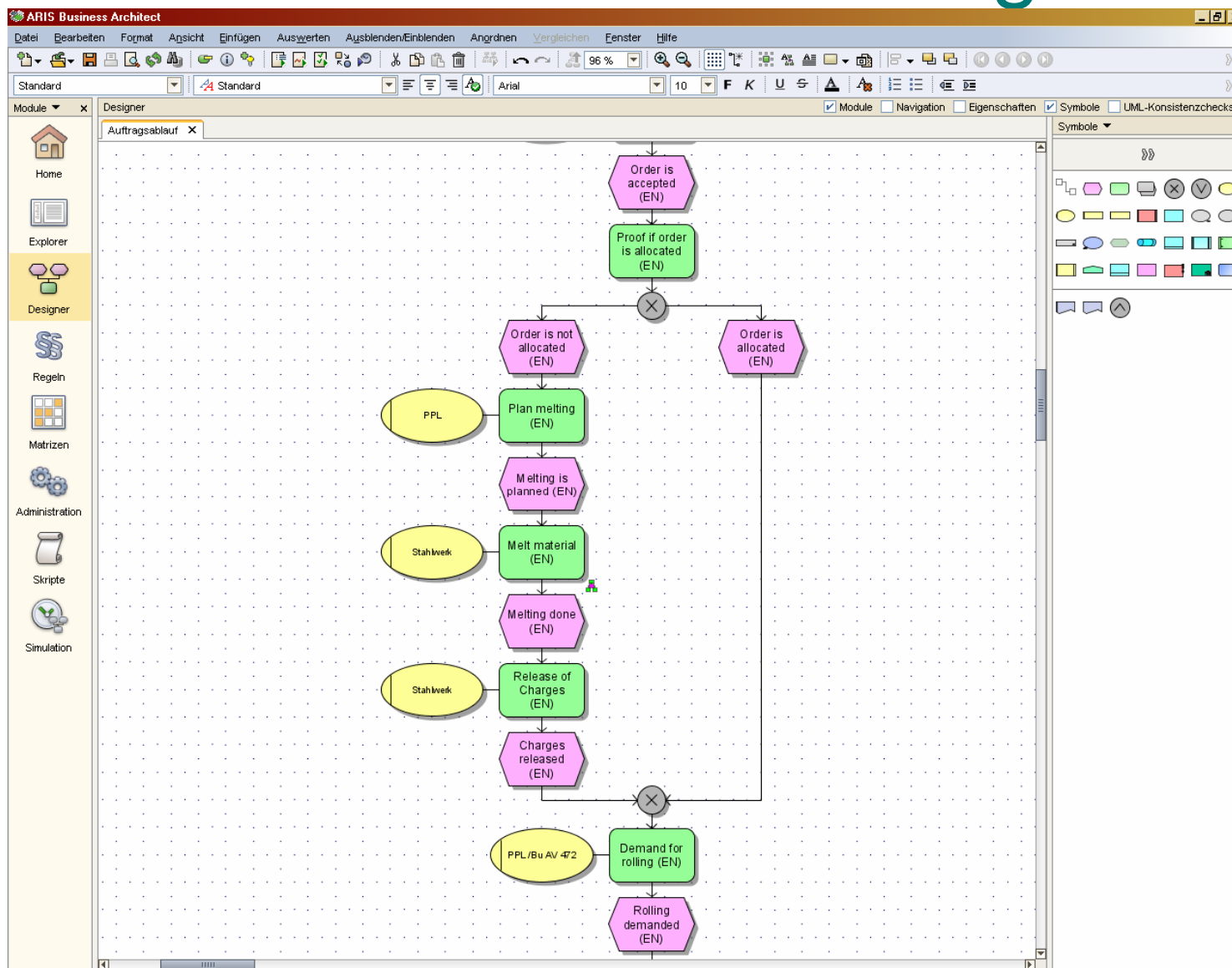

# CIMFlex EPC Modeling

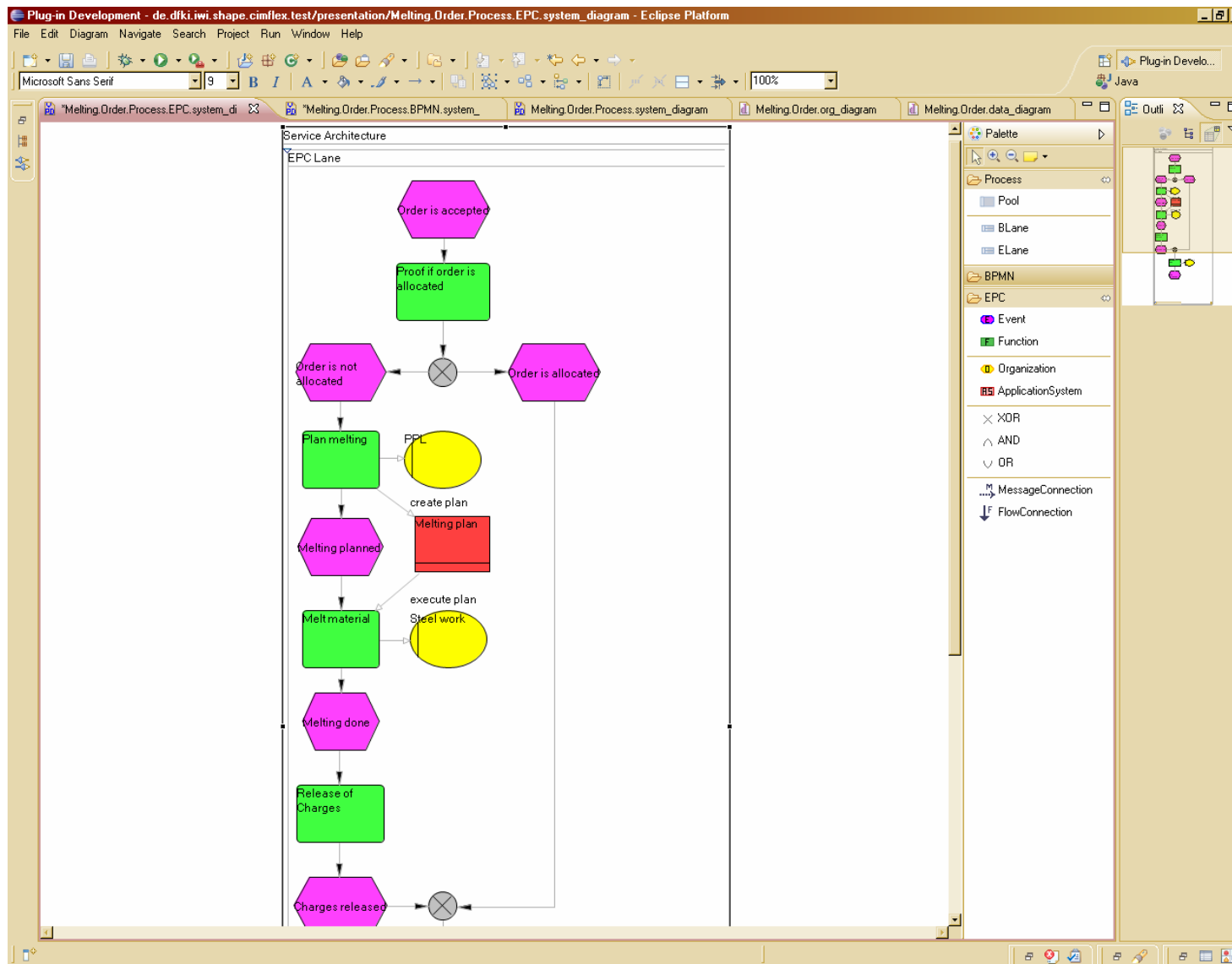

# Agenda

- Process Modeling
- Organizational and Operational Structure
- **ARIS / EPC** and BPMN:
  - Overview
  - **Modeling Concepts**

# EPC: Event

## ■ Event:

- An event describes a business-relevant occurrence at an object which either controls or influences the continuation of a business process.
- Events represent a state or status in the process
- Since an event generally has something to do with a "piece of data", i.e. a status description, events are originally assigned to the data view.
- Events act as triggers for activities, but are also based on preceding functions and therefore describe an event.
- Events are named using Object - Past Participle

<u>Object</u>	<u>Past Participle</u>
Expense	Incurred
Expense report	Approved
Hard copy	Filed

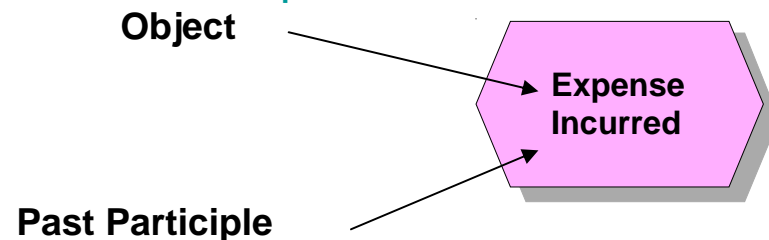

# EPC: Function

## ■ Function:

- A function is a technical task, a procedure, and/or an activity performed on an object to support one or more company goals.
- The function is a carrier of times and costs.
- Functions represent where change occurs in the process.
- Functions are named using Verb - Object

<u>Verb</u>	<u>Object</u>
Prepare	Expense report
Review	Expense report
Mail	Refund check

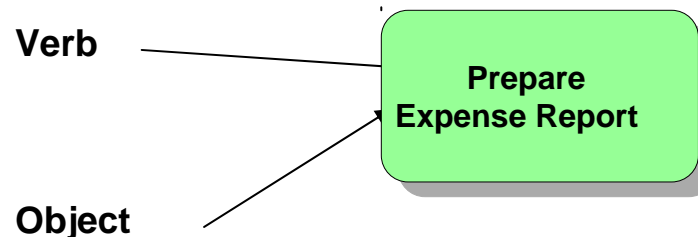



# EPC: Modeling Constructs

- Logical Connectors:
  - Describe different forms of process branching
  - Split: The process splits its flow at this connector
  - Join: Part processes converge
- Types:
  - Conjunction („and“)
  - Disjunction („exclusive or“)
  - Adjunction („inclusives or“)
- Control Flow:
  - Reflection of the chronologically inherent flow of Events and Functions



# Symbols of EPC and eEPC

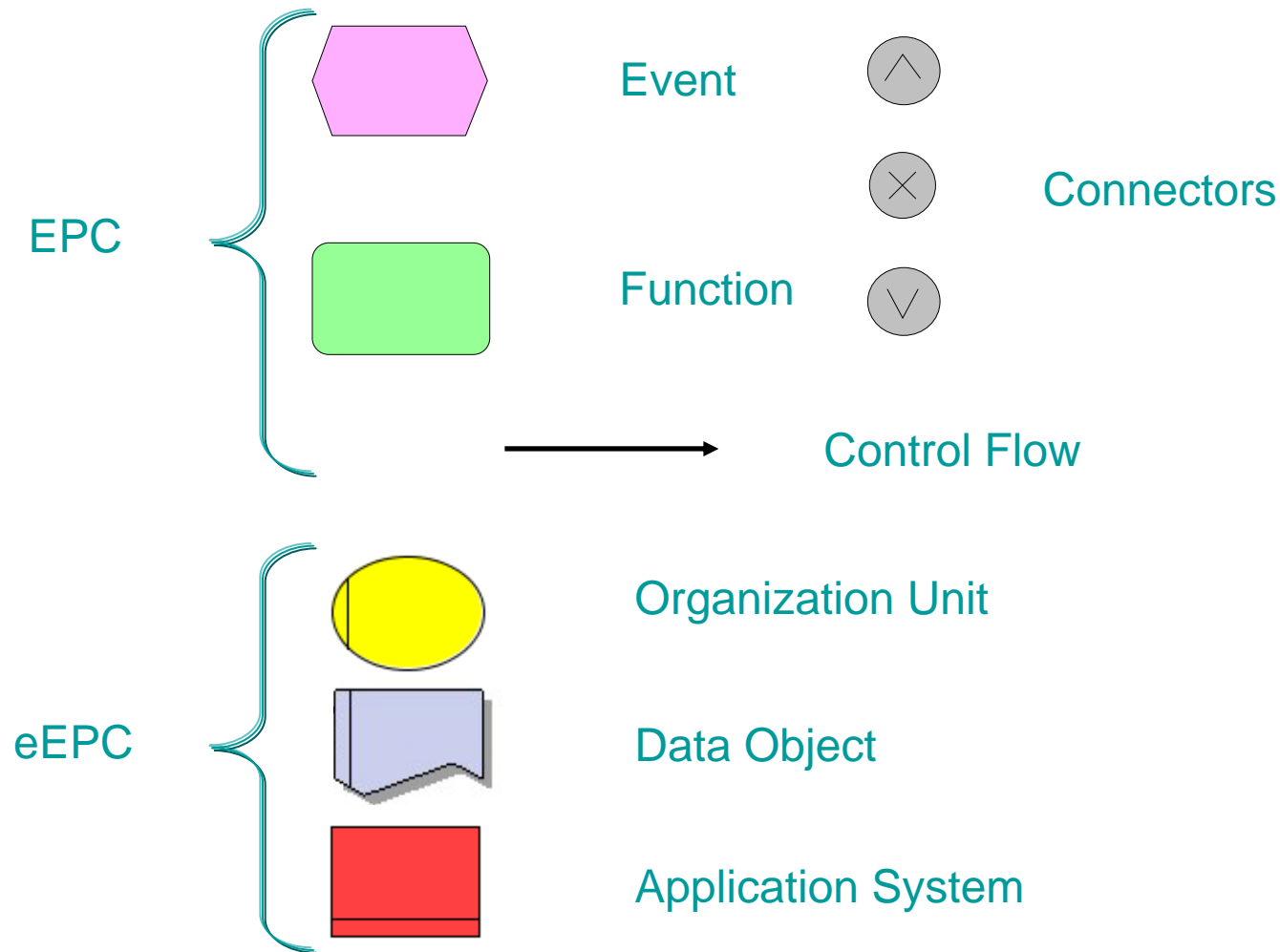

# EPC: Modeling Concepts

- EPC follow an event-function-event structure
- EPC must begin and end with events
- Logical branches in the chronological flow of the process are represented by **rules** in the form of logical operators (**AND**, **OR**, **XOR**)
- Branching is done with three types of connectors:
  - AND
  - OR
  - XOR (exclusive OR)



# EPC: Modeling Concepts

Events trigger functions

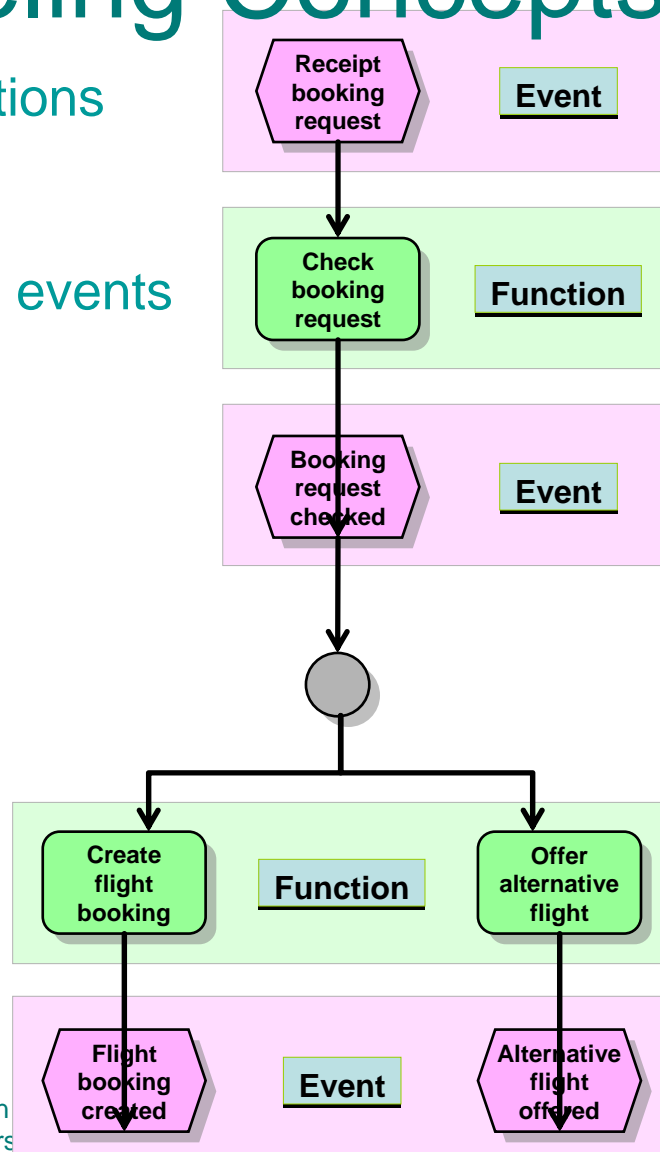
Functions generate events

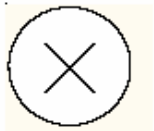
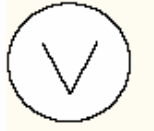

# EPC: Connectors Explained

Name	Symbol	Significance when separating the paths	Significance when merging the paths
Exclusive OR		<b>Only one</b> of the possible process paths must be followed	<b>The following process flow will be initiated from only one of the possible process paths.</b>
Open OR		<b>At least one</b> of the possible process paths must be followed	The following process flow will be initiated by <b>at least one</b> of the possible process paths.
AND		<b>All outgoing</b> process paths must be followed	<b>All incoming</b> process paths trigger the following process flow. If one of the paths has not yet been fully completed, then the process pauses at this point until all incoming process paths have been completed.



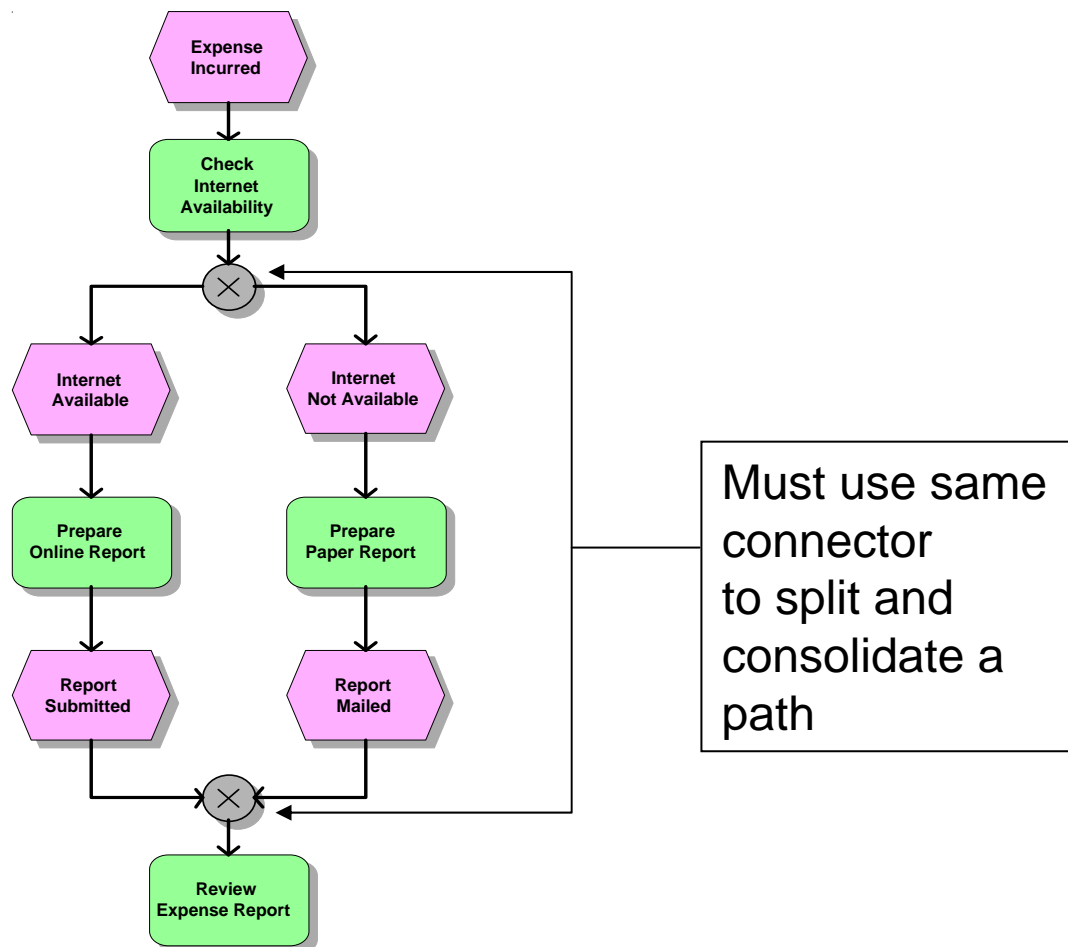

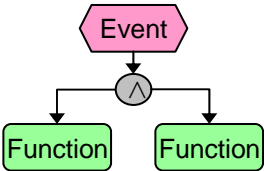
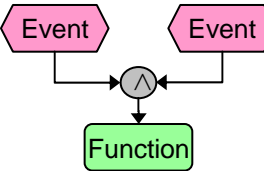
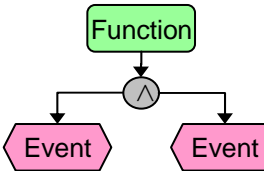
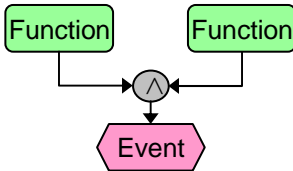
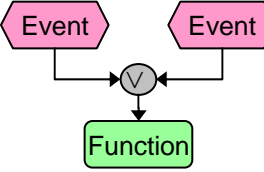
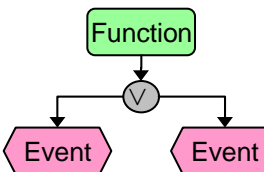
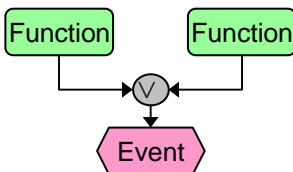
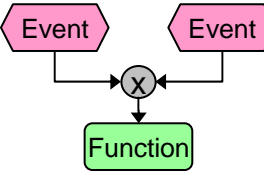
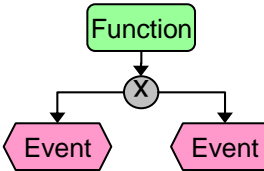
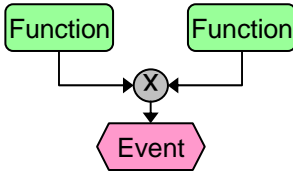

# EPC: Splitting and Joining Process Paths



# Possible Connector Combinations

	Event Trigger		Function Trigger	
	Single	Multiple	Single	Multiple
AND				
OR	Not Allowed			
XOR	Not Allowed			

# EPC: Modeling Rules

-  An eEPC begins and ends with an event(s) (or with process interface(s)).
-  The sequential order Event - Function - Event - Function must be followed (can only be interrupted by logical link operators).  
You can however omit trivial events.  
Trivial events = Events in a sequence in the middle of the process flow.
-  Link operators are to be used for several process paths.
-  Link operators (rules) have either one incoming connection and several outgoing connections, or several incoming connections and one outgoing connection.
-  In order to merge process paths, the same connector must be used as was used for the branch.
-  No OR operator or exclusive OR (XOR) operator may follow an individual event.



# EPC Modeling Example

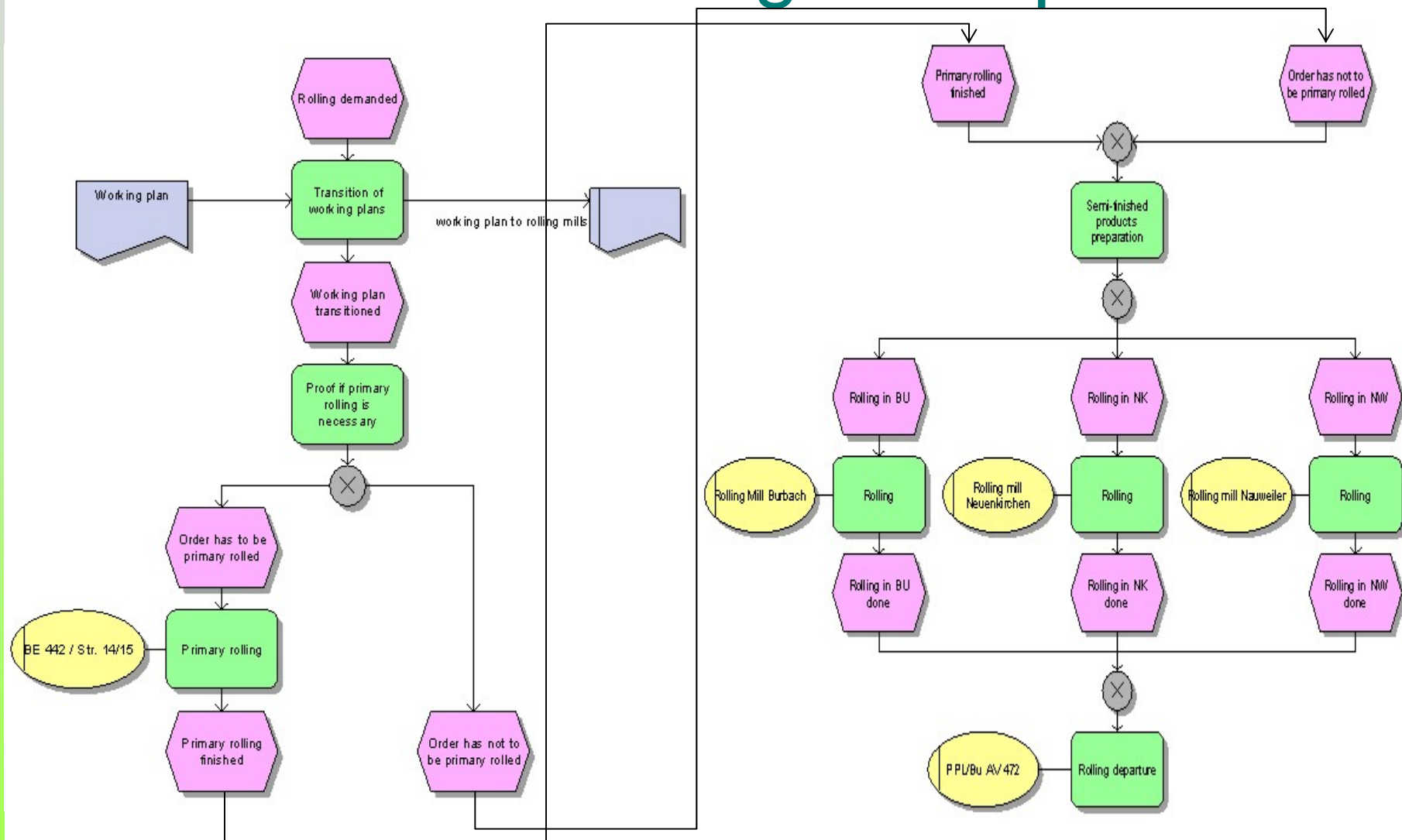

# Agenda

- Process Modeling
- Organizational and Operational Structure
- ARIS / EPC and **BPMN**:
  - **Overview**
  - Modeling Concepts

# BPMN: Overview

- Notation Working Group formed in 2001
- Consisted of 35 companies, organizations and individuals
- BPMN released in 2004, adopted as OMG standard in 2006
- Purely graphical flow-chart based notation
- Single notation agreement between modeling tool vendors

# BPMN: Tools Examples

- Industrial (54 total implementing tools):
  - Objecteering
  - ARIS
- Research:
  - CIMFlex – SHAPE project
  - YAWL – Queensland University of Technology

# Objecteering BPMN Modeling

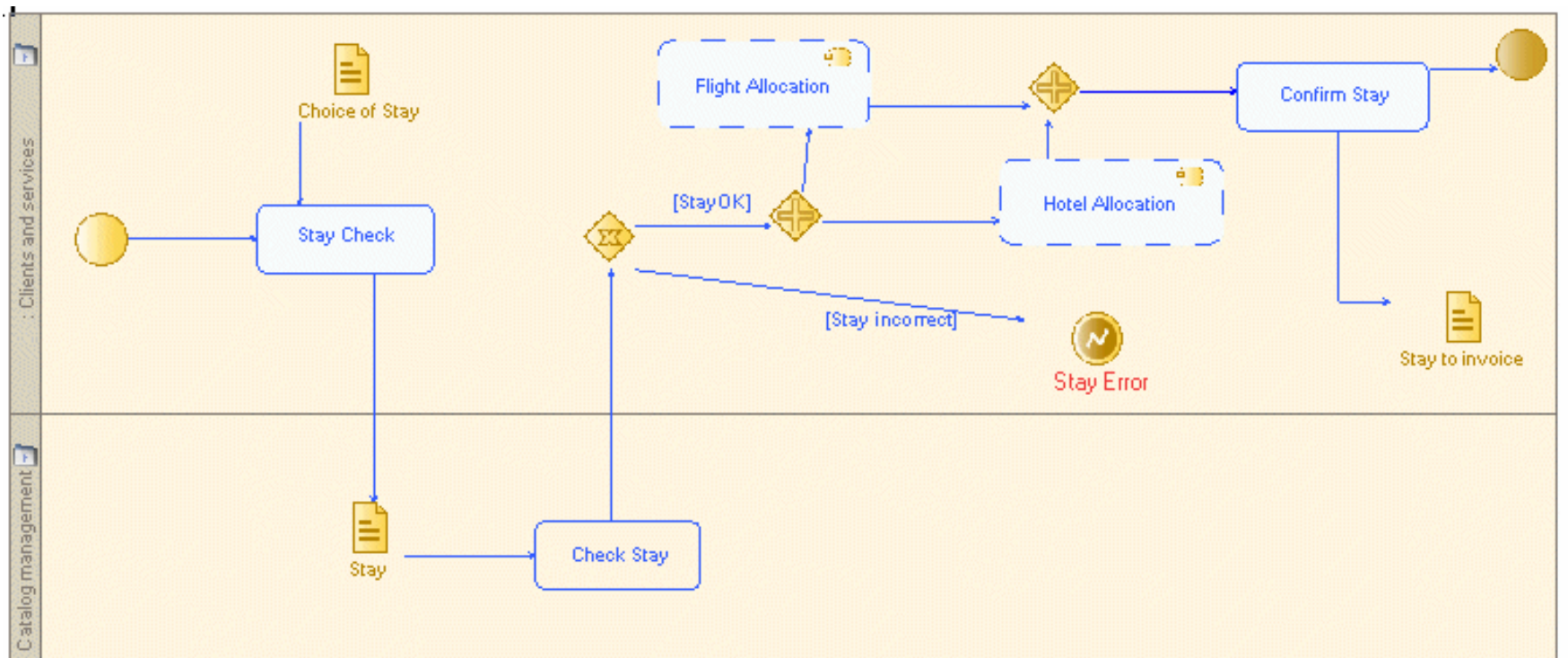

# CIMFlex BPMN Modeling

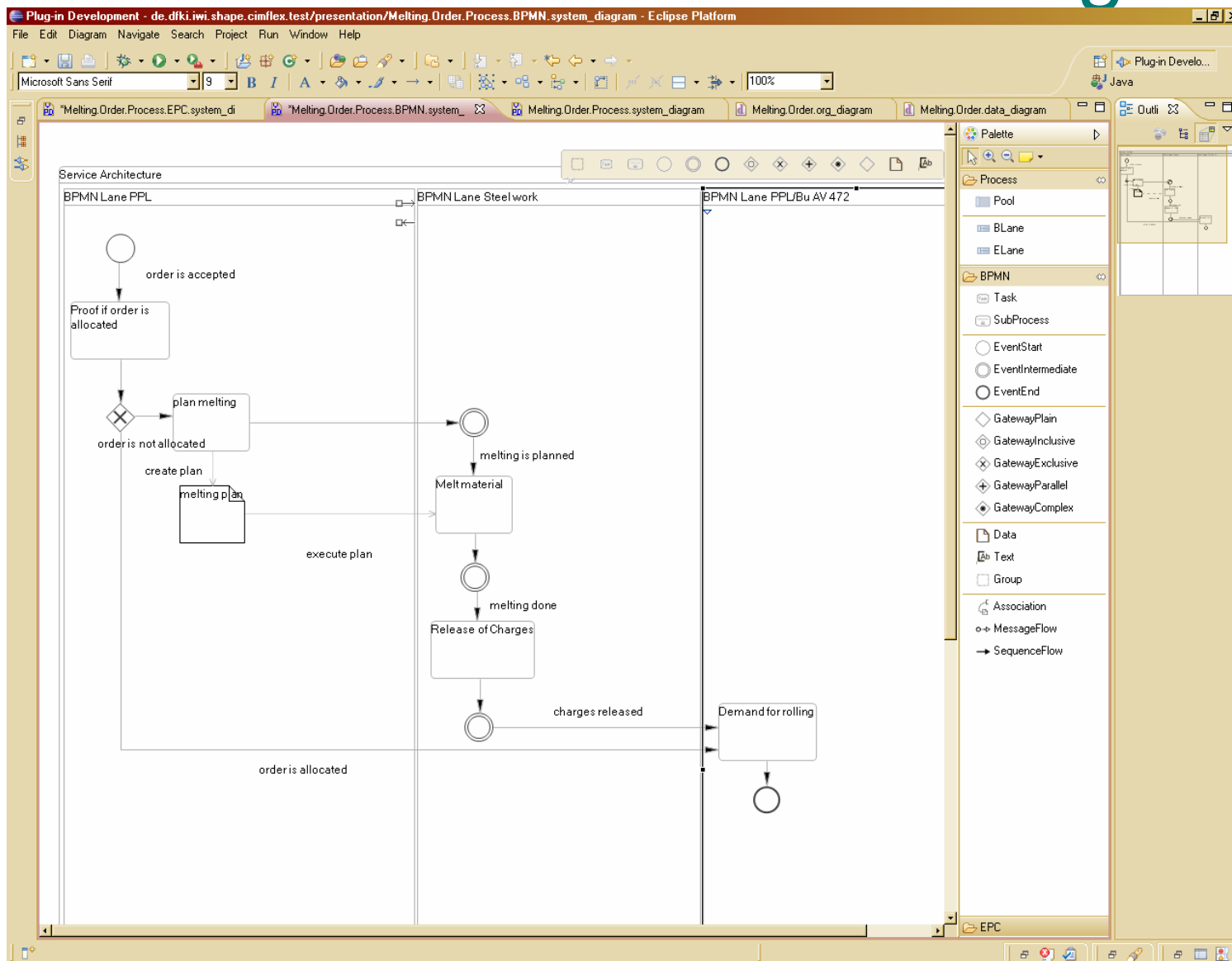

# Introduction

## Definition of BPMN

- Business Process Modeling Notation (BPMN)
  - BPMN provides businesses with the capability of defining and understanding their internal and external business procedures through a Business Process Diagram, which will give organizations the ability to communicate these procedures in a standard manner. BPMN also is supported with an internal model that will enable the generation of executable BPEL4WS.

# BPMI.org Hourglass

**Audiences:** Business Environment

**Purposes:**

Strategy Consultants

Business Analysts

Process Designers

System Architects

Software Engineers

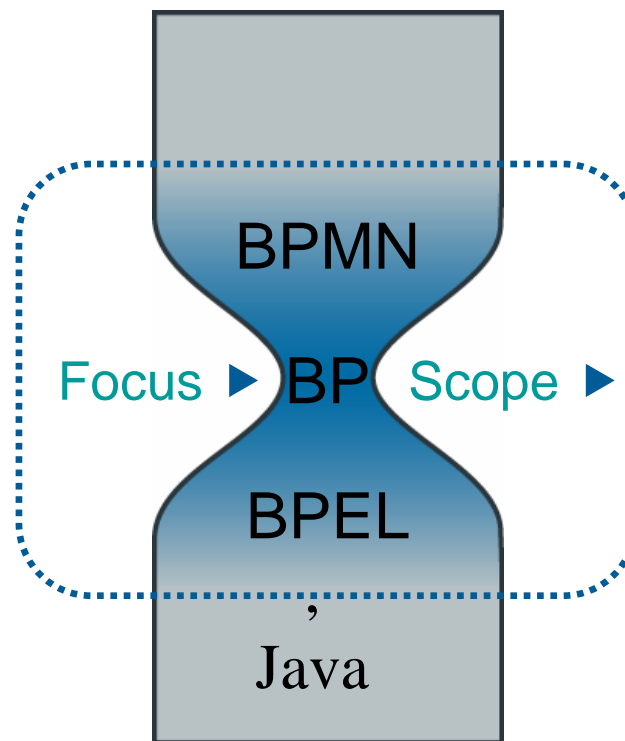

↑  
Modeling

Execution  
↓

Technology Implementation



# Agenda

- Process Modeling
- Organizational and Operational Structure
- ARIS / EPC and **BPMN:**
  - Overview
  - **Modeling Concepts**

# Core Set of Diagram Elements

## Events



## Sequence Flow



## Activities



## Message Flow



## Gateways

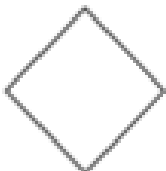

## Association



- The core set of modeling elements enable the easy development simple Business Process Diagrams that will look familiar to most Business Analysts (a flowchart diagram)

# BPMN Diagram elements

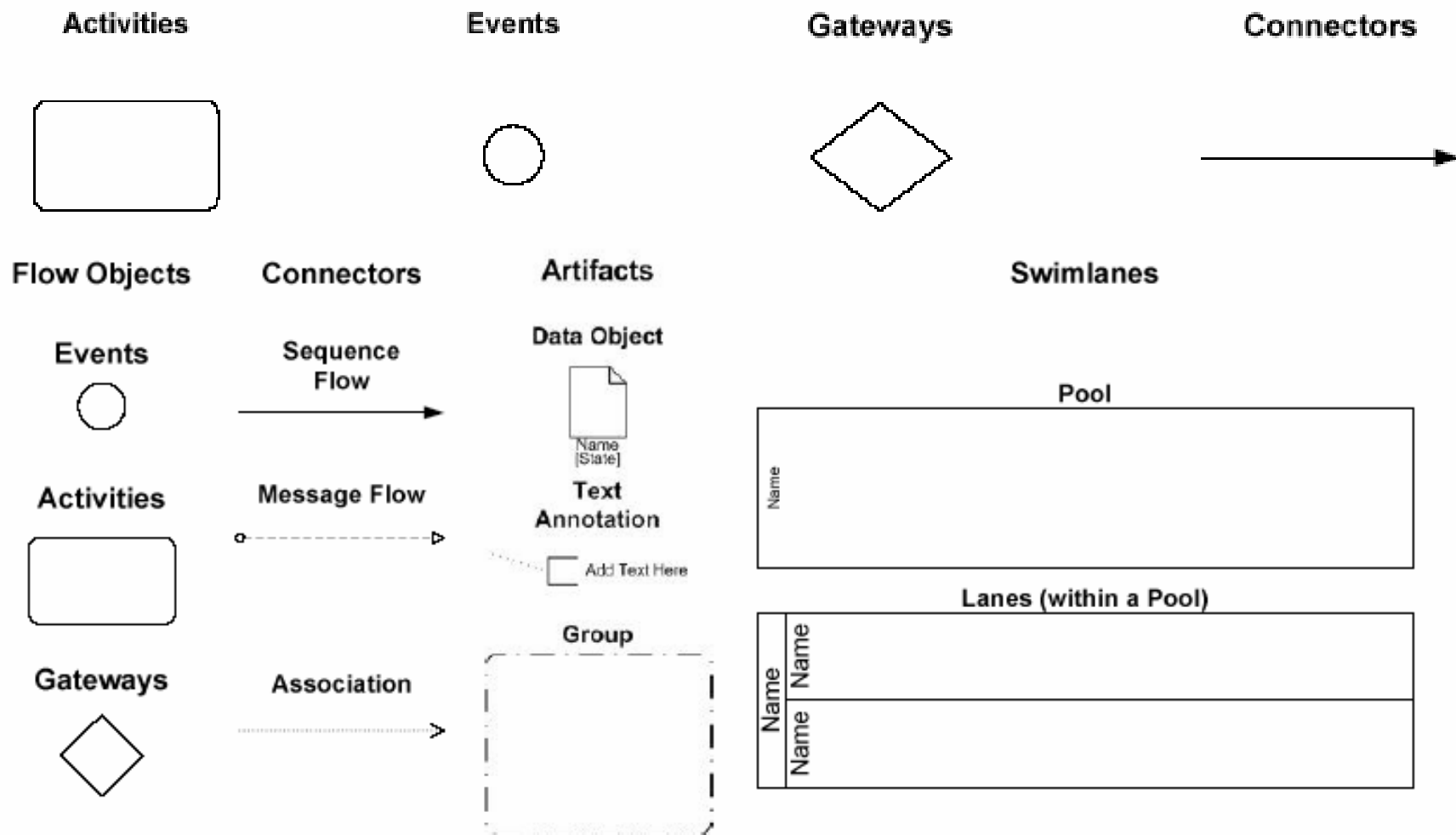

# Task

- A Task is an atomic activity that is included within a Process. A Task is used when the work in the Process is not broken down to a finer level of Process Model detail.
- There are specialized types of Tasks for sending and receiving, or user-based Tasks, etc.
- Markers or icons can be added to Tasks to help identify the type of Task
- Markers must not change the footprint of the Task or conflict with any other standard BPMN element

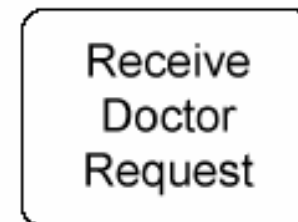
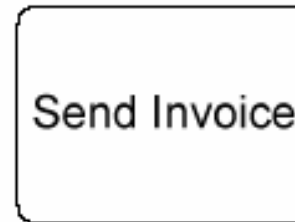

# Sub-processes

- Sub-Processes enable hierarchical Process development
- A Sub-Process is a compound activity that is included within a Process. It is compound in that it can be broken down into a finer level of details (a Process) through a set of sub-activities
- For a collapsed version of a Sub-Process, the details of the Sub-Process are not visible in the Diagram. A “plus” sign in the lower-center of the shape indicates that the activity is a Sub-Process and has a lower level of detail
- For an expanded version of a Sub-Process, the details (a Process) are visible within its boundary
- There are two types of Sub-Processes: Embedded and Independent (reusable)

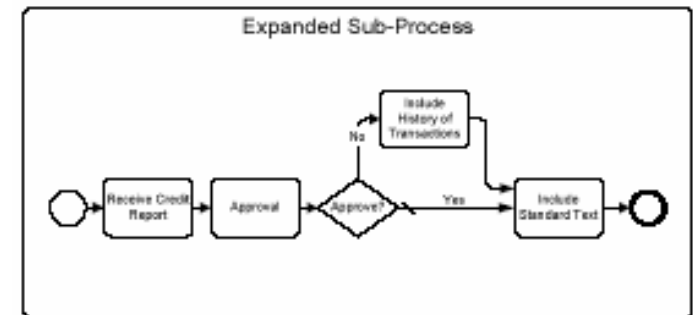
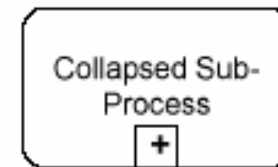

# Pool

- Pools represent Participants in an interactive (B2B) Business Process Diagram
- A Participant may be a business role (e.g. buyer or seller) or may be a business entity (e.g. IBM or OMG)
- A Pool may be a “black box” or may contain a Process
- Interaction between Pools is handled through Message Flow
- Sequence Flow cannot cross the boundary of a Pool (i.e. a Process is fully contained within a Pool)

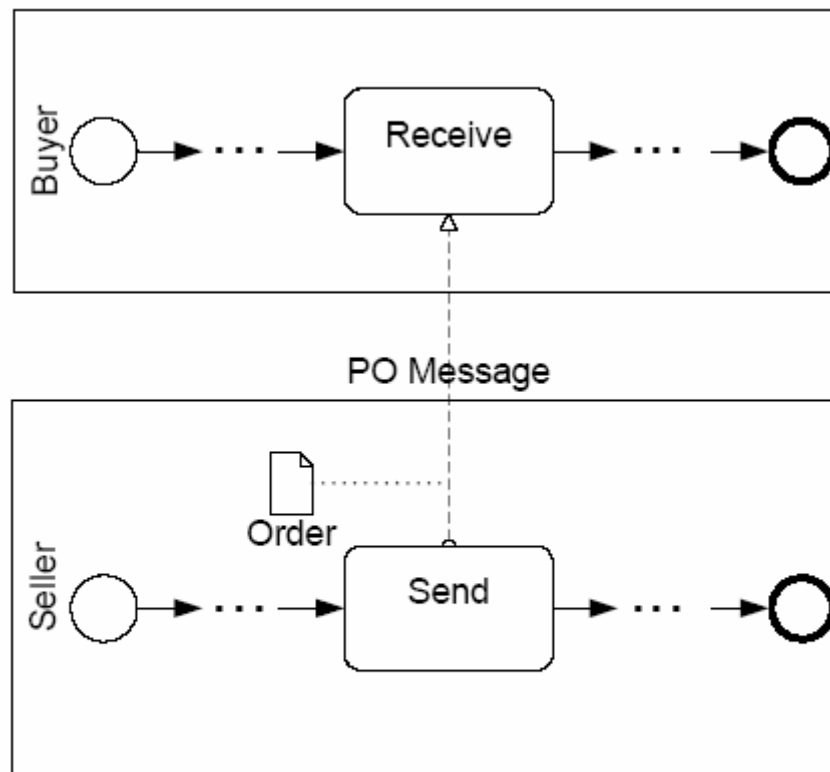

# Lanes

- Lanes represent sub-partitions for the objects within a Pool
- They often represent organization roles (e.g. Manager, Associate), but can represent any desired Process characteristic
- Sequence Flow can cross Lane boundaries

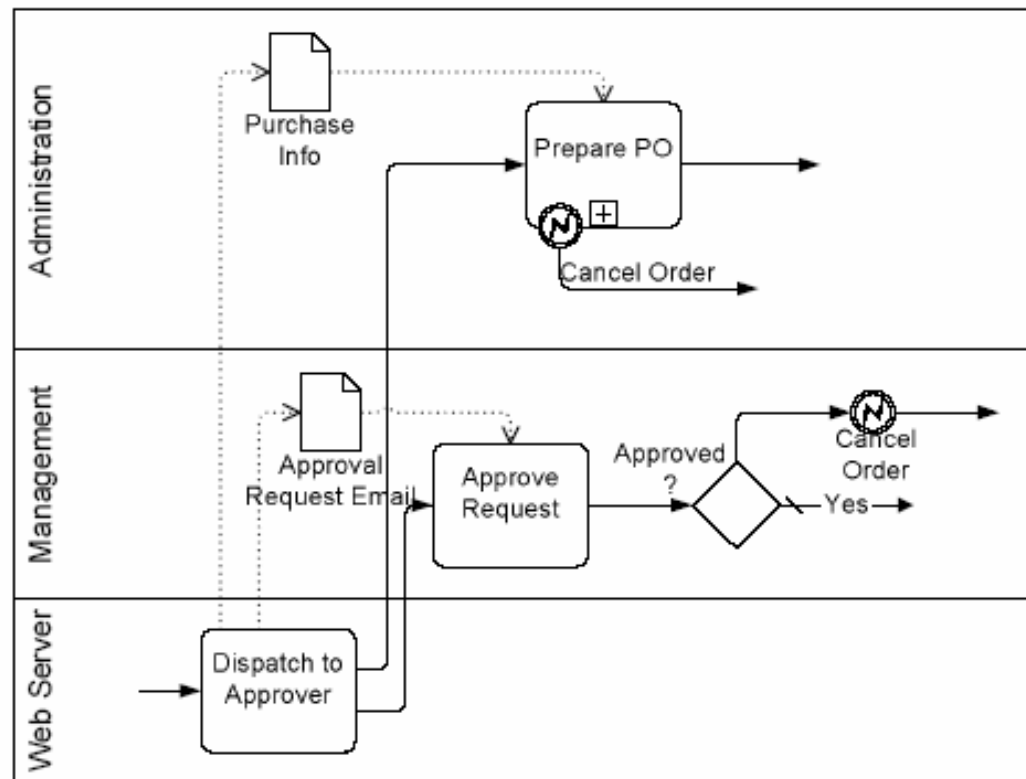

# Connectors

## Sequence Flow



## Message Flow



## Association

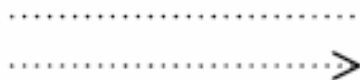

- A Sequence Flow is used to show the order in that activities will be performed in a Process
- A Message Flow is used to show the flow of messages between two entities that are prepared to send and receive them
- An Association is used to associate data, information and artifacts with flow objects



# Gateways

## Exclusive

Data-Based

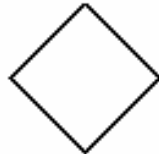

Event-Based



## Inclusive



## Complex



## Parallel



- Gateways are modeling elements that are used to control how Sequence Flows interact as they converge and diverge within a Process
- All Types of Gateways are diamonds
  - Different internal markers indicate different types of behavior
  - All Gateways both split and merge the flow
- If the flow does not need to be controlled, then a Gateways is not needed. Thus, a diamond represents place where control is needed

# Exclusive Gateways

- Exclusive Gateways (Decisions) are locations within a business process where the Sequence Flow can take two or more alternative paths. This is basically the “fork in the road” for a Process
- Only one of the possible outgoing paths can be taken when the Process is performed
- There are two types of decision mechanisms:
  - Data (e.g. condition expressions)
  - Events (e.g. the receipt of alternative message)
- They are also used to merge Sequence Flow
  - The merging behavior may change in the next version of BPMN

# Exclusive Gateways, based on data

- These are the most commonly used type of Gateways:
  - Can be shown with or without an internal “X” marker. Without is the most common usage
- The Gateways (Decisions) create alternative paths based on defined conditions

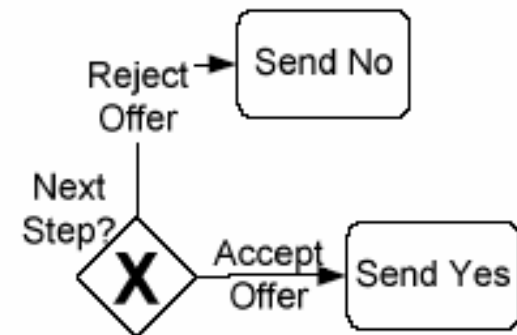
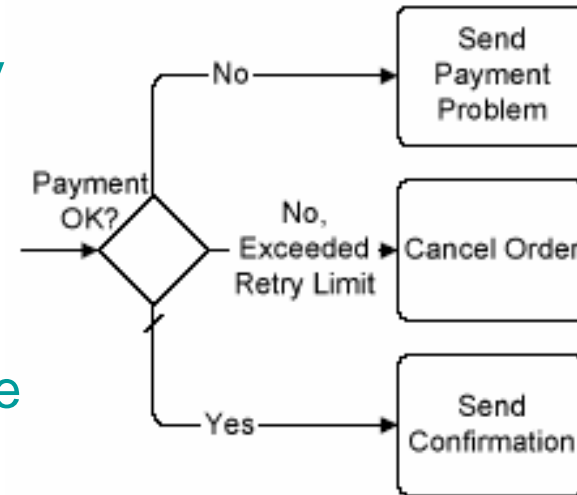

# Exclusive Gateways, based on events

- This type of Decision represents a branching point in the process where the alternatives are based on events that occur at that point in the Process, rather than conditions
- The Multiple Intermediate Event is used to identify this Gateway
- The Event that follows the Gateway Diamond determines the chosen path
  - The first Event triggered wins

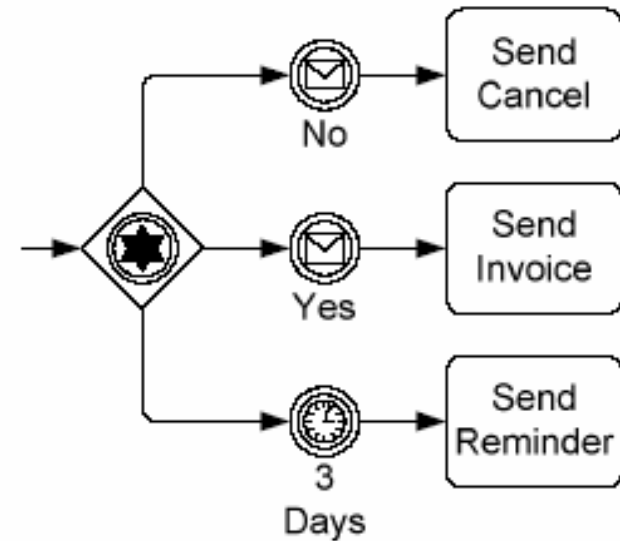

# Inclusive Gateways

- Inclusive Gateways are Decisions where there is more than one possible outcome
- The “O” marker is used to identify this Gateway
- They are usually merging Inclusive Gateway

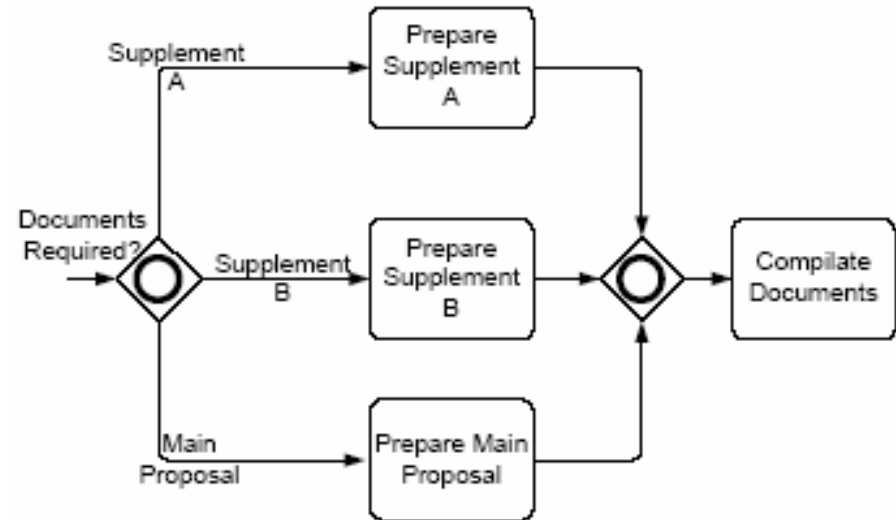

# Complex Gateways

- Complex Gateways are Decisions where there is more advanced definitions of behavior can be defined
- The asterisk marker is used to identify this Gateway
- Complex behavior can be defined for both the merging and splitting behavior

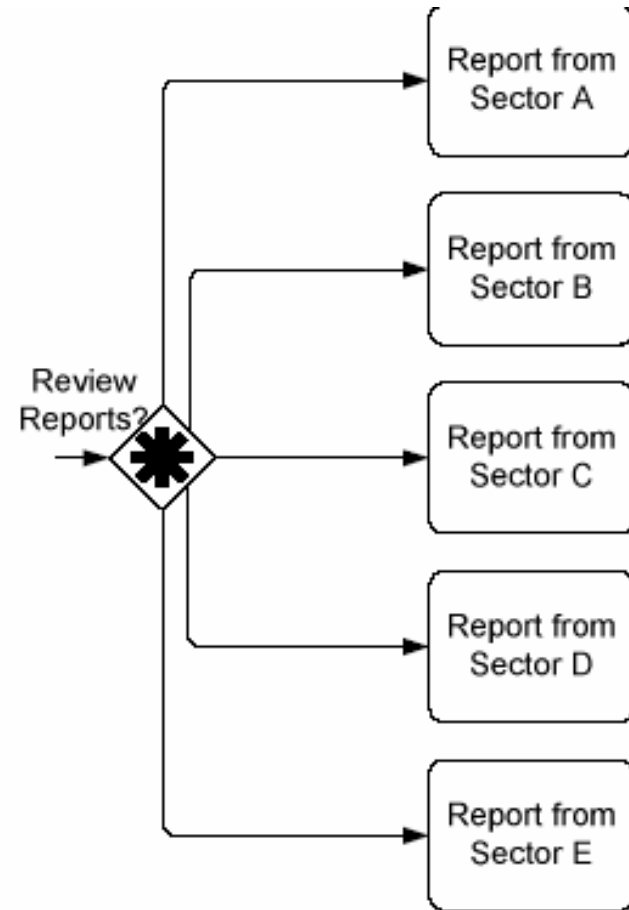

# Parallel Gateways

- Parallel Gateways are places in the Process where multiple parallel paths are defined:
  - They are not required for forking in most situations
  - They can be used for methodological purposes
- The “+” marker is used to identify this Gateway
- The Gateway is also used to synchronize (wait for) parallel paths

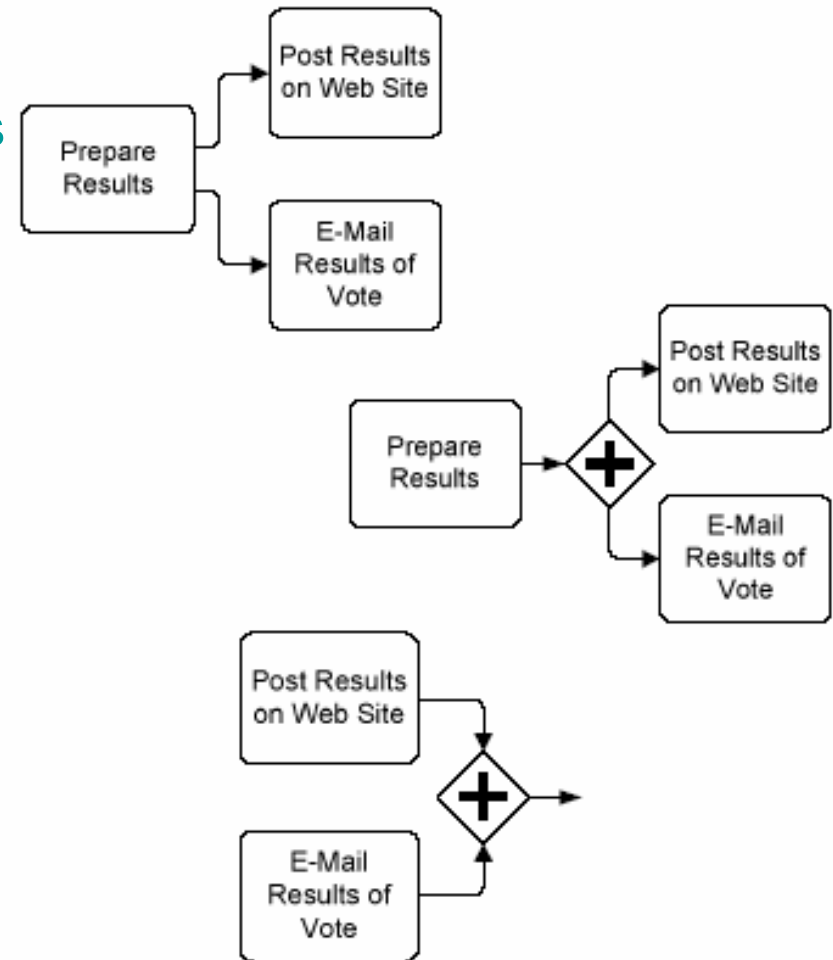

# Complete Set of Diagram Elements, Events

## Events



## Event Types

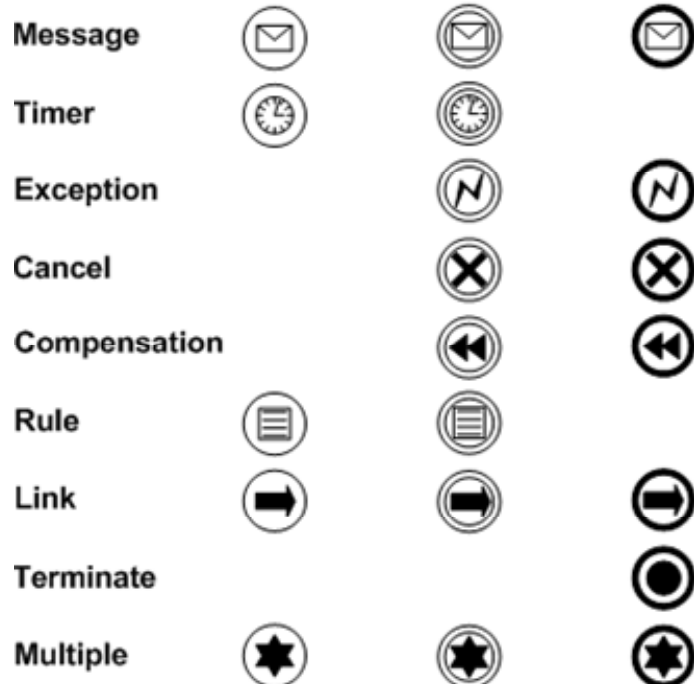

■ An Event is something that “happens” during the course of a business process. These Events affect the flow of the Process and usually have a trigger or a result. They can start, interrupt, or end the flow.



# Complete Set of Diagram Elements, Gateways

## Gateways

### Exclusive Decision/Merge (XOR)

Data-Based

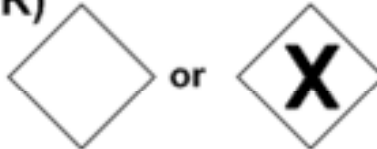

Event-Based



### Inclusive Decision/Merge (OR)



### Complex Decision/Merge



### Parallel Fork/Join (AND)



Gateways are modeling elements that are used to control how Sequence Flows interact as they converge and diverge within a Process. If the flow does not need to be controlled, then a Gateway is not needed.

, Norway

Ulf Larsson, LFV, Sweden

Dima Panfilenko, DFKI IWi, Germany

# BPMN Modeling Example

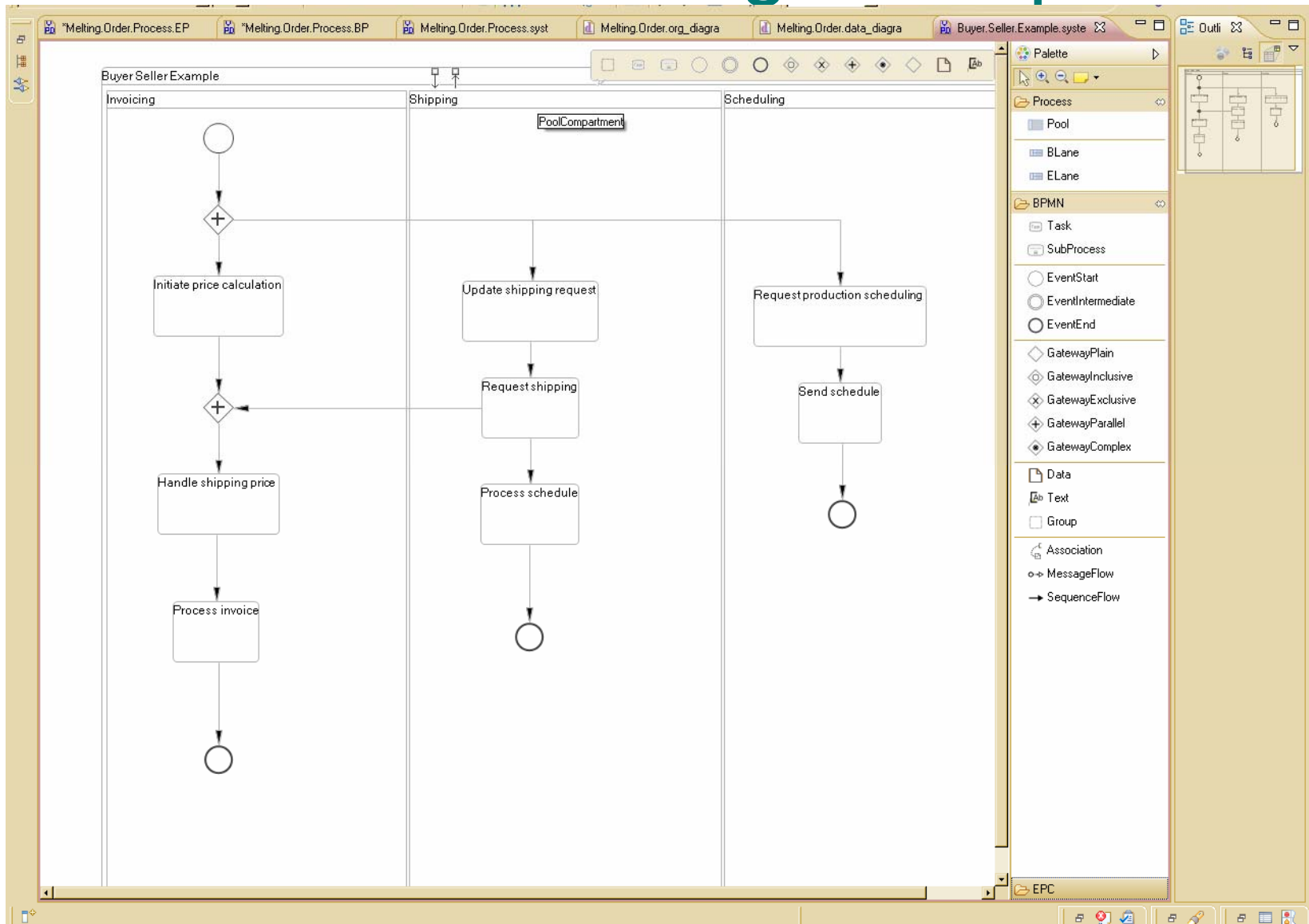

# EPC or BPMN?

## EPC

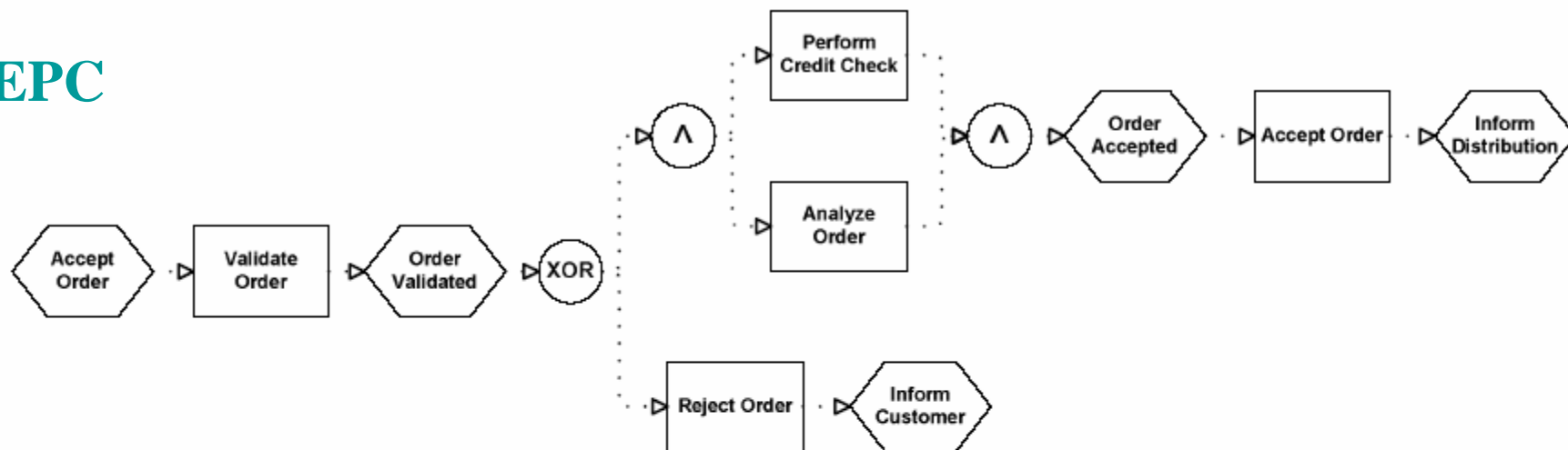



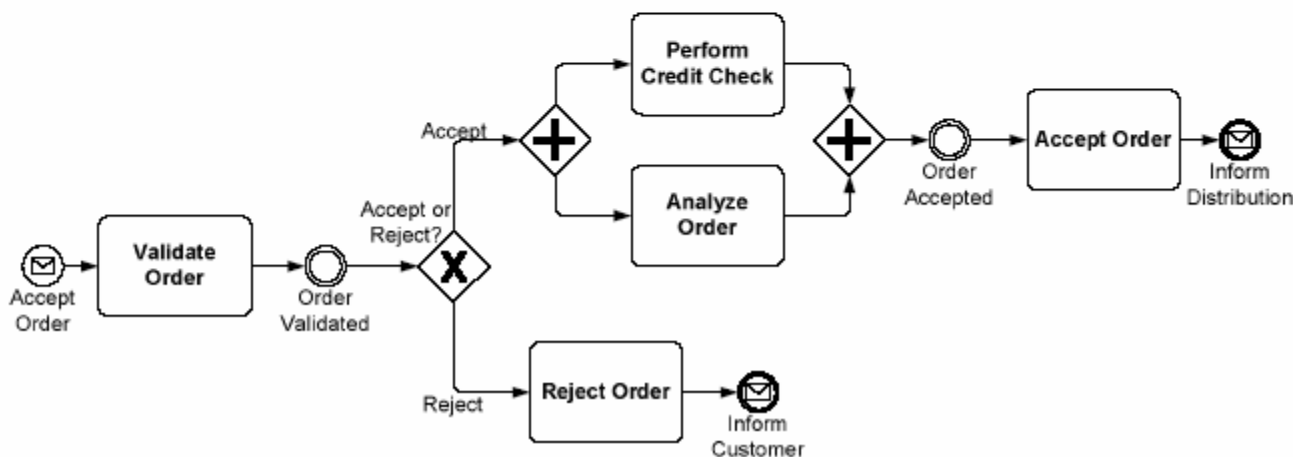







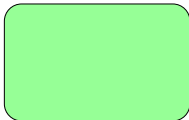

## BPMN



# EPC – BPMN Comparison Matrix

	eEPC	BPMN
Structuredness	O	O
Expressivness	O	X
Semantical Annotations	X	X
Analysability	X	X
Formalization degree	X	X
Information flow support	O	O

# EPC – BPMN Mapping

Function			Task
Event			Start Event
			End Event
XOR			Data-Based Exclusive Gateway
AND			Parallel Gateway
OR			Inclusive Gateway
Control Flow			Sequence Flow

# eEPC – BPMN Mapping

Organization Unit

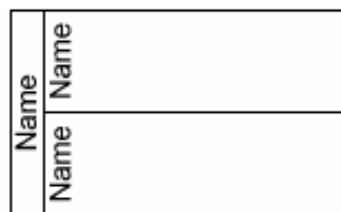
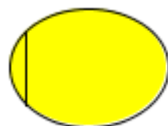

Lane

Data Object

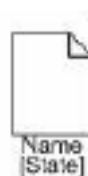
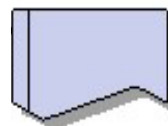

Data Object

Application System



Text Annotation

# BPMN 1.0 – 2.0

- 2 current proposals, discussing alignment,
  - One focusing on notation and the other on metamodel
  - Plan for completion in 2009
  
- Services architectures
  
- Participants architectures
  
- Data view?